

**PHILIPS**

hue personal  
wireless  
lighting

Adore



HUE serial number



User manual  
Benutzerhandbuch  
Notice d'emploi  
Manual de usuario  
Manual do usuário  
Manuale d'uso

Incl.

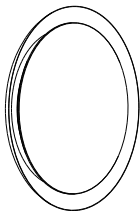

1 x CR2032



Excl.

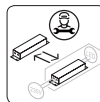
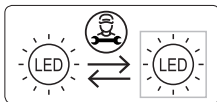
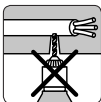
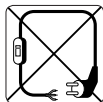
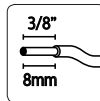
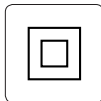
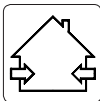
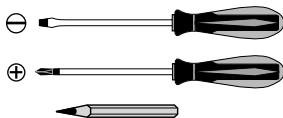
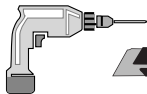

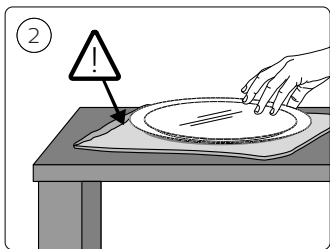
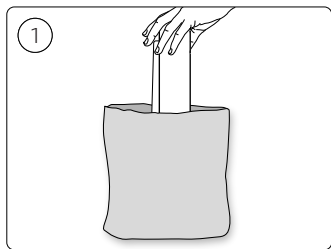
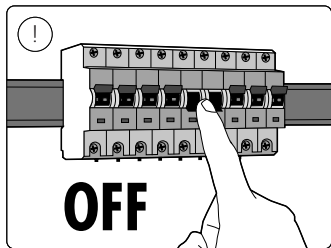

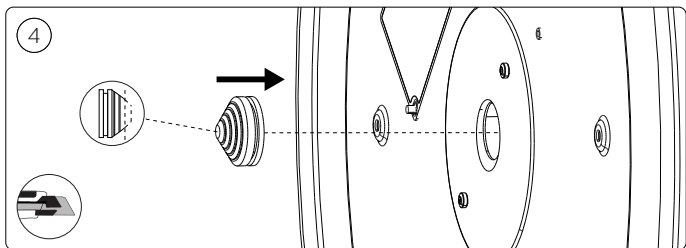
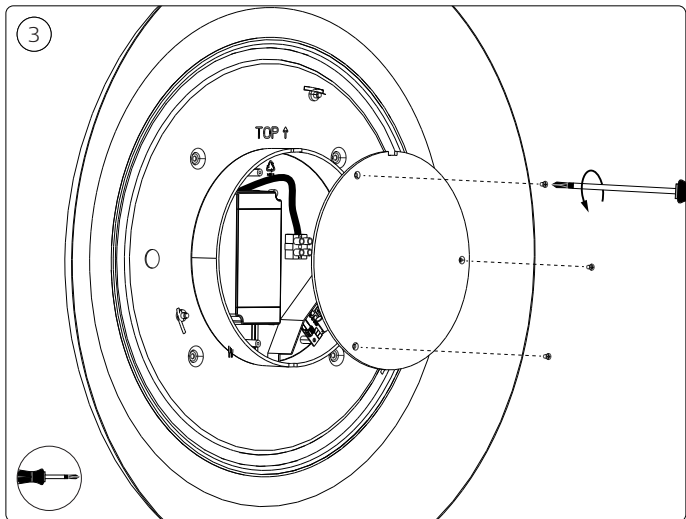

5

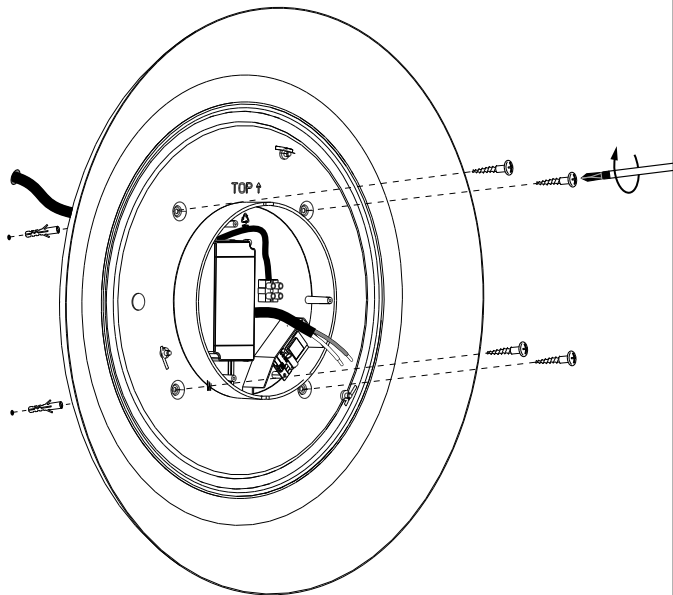

6

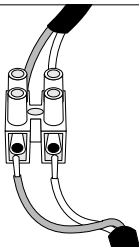

7

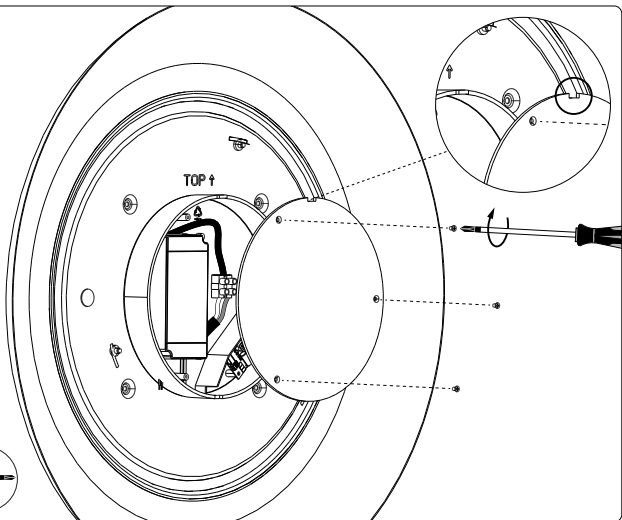

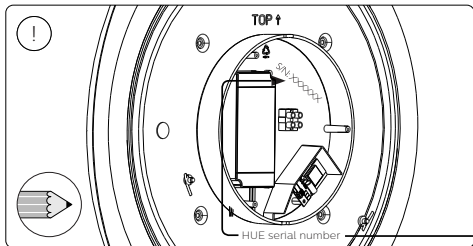
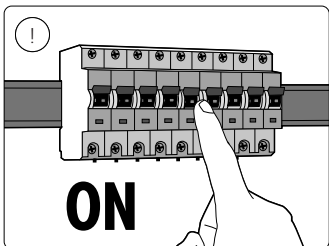
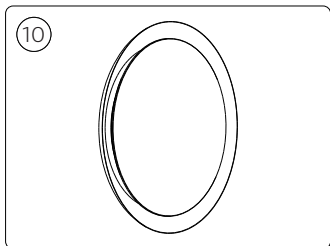
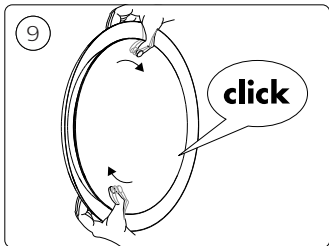
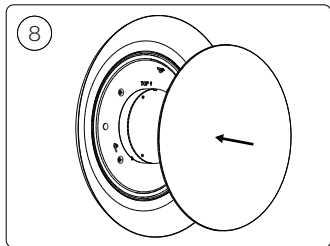

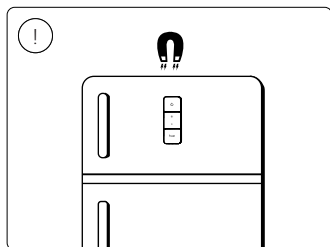
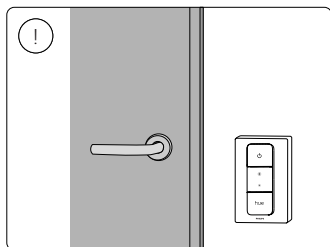
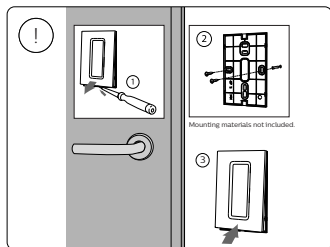
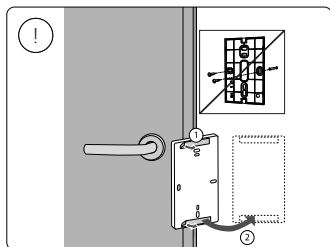
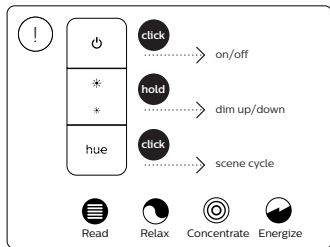
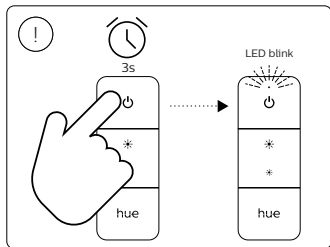



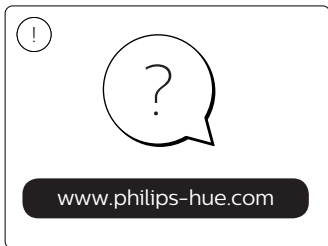
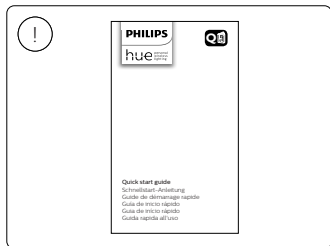







Signify  
I.B.R.S. / C.C.R.I. Numéro 10461  
5600 VB Eindhoven,  
the Netherlands  
☎00800-74454775

Signify Australia Limited  
65 Epping Road, North Ryde,  
NSW, 2113 Australia  
Toll Free number: 1300 304 404

Signify New Zealand Limited  
123 Carlton Gore Road  
Newmarket, Auckland 1023  
New Zealand  
Tel: 0800 454 448

© 2021 Signify Holding  
All rights reserved

[www.philips-hue.com](http://www.philips-hue.com)

4404 029 09195  
Last update: 09/2021